

NEW
Colori RAL
RAL colours



2012 K S/2

Estraibile / Extractable

Corpo in estruso di alluminio, lente in policarbonato o riflettore 60° in alluminio
Body in extruded aluminium, polycarbonate lens or aluminium reflector 60°

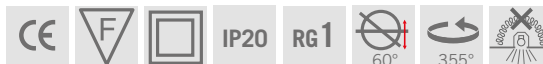
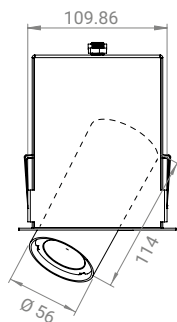
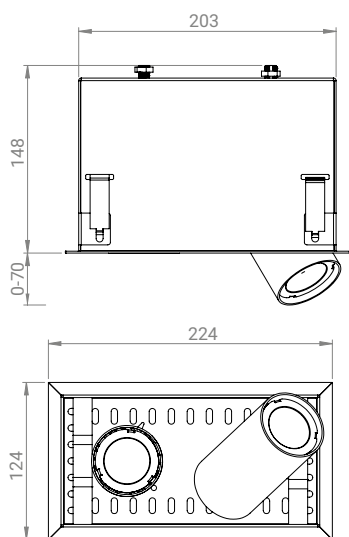

Accessori / Accessories

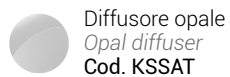
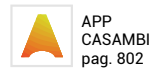
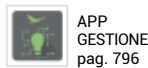



Scelta del / Choice of



Fascio / Beam

Lente
Lens

F **M**
24° 38°

Riflettore
Reflector

T
60°



Colori RAL / RAL colours

9006 Grigio Grey	9016 Bianco White	9005 Nero Black	3001 Rosso Red
2004 Arancio Orange	1021 Giallo Yellow	6029 Verde Green	5026 Blu Metal Metal Blue



Driver / Driver

E
Driver standard
Standard driver

D
Driver dimmerabile
Dimmable driver

L
Driver dimm. Dali
Dali dimm. driver

Scelta del / Choice of



E



D

L

IRC/CRI >80

A++

lm	K	W	mA	Cod.	E	D	L
3160	2700	2x12	350	2012RB			
3320	3000	2x12	350	20125B			
3490	4000	2x12	350	20126B			

IRC/CRI >90

A+

lm	K	W	mA	Cod.	E	D	L
2700	2700	2x12	350	2012ZB			
2830	3000	2x12	350	20127B			
2990	4000	2x12	350	20128B			

IRC/CRI >90

FASHION

A+

lm	K	W	mA	Cod.	E	D	L
3060	3250	2x12	350	2012WB			

IRC/CRI 98

ART

A+

lm	K	W	mA	Cod.	E	D	L
2900	3000	2x12	350	2012QB			

NB: consigliamo l'utilizzo dei cavetti di sincronizzazione per driver dimmerabili - vedi pag. 805
we suggest to use synchronization wires for dimmable drivers - see page 805

Esempio codice
Example code

2012QB → **F9005E**



Per un prodotto da 2900 lm · 3000 K · 2x12 W
350 mA · Fascio 24° · Colore nero · Driver standard
For a product to be 2900 lm · 3000 K · 2x12 W
350 mA · Beam 24° · Black colour · Standard driver

24°

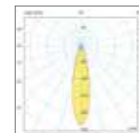

38°

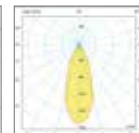

60°

